

# Directions for Assembling, Installing and Using the Universal Spa Cover Lifter

Your **UNIVERSAL** Spa Cover Lifter requires minimal assembly after it is unpackaged.

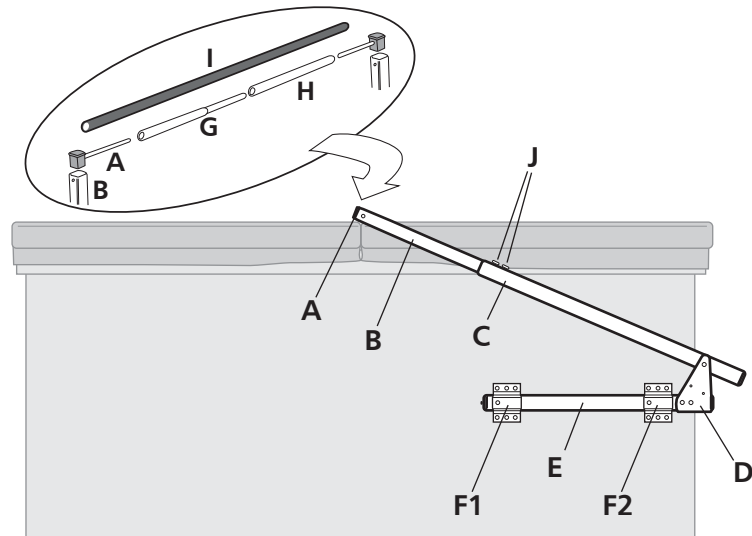

## To assemble and install:

1. Remove the tape and 1/2" #8 self-drilling screw from Adjustment Bar **B**.

2. Insert Connector Bar **A** into Adjustment Bar **B** and fasten with the 1/2" #8 self-drilling screw.

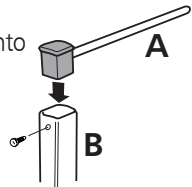

3. Place Connector Bar **A** on the spa cover center seam.

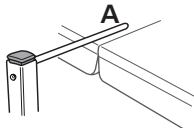

4. While sliding the Adjustment Bar **B** out of the Pivot Bar **C**, locate where you want to mount the UNIVERSAL Spa Cover Lifter on your spa or deck.

Note: if mounting on deck, brackets **F1** and **F2** must first be turned 90° on Main Bar **E**.

5. End of Main Bar **E** with Bracket **F1** should be fastened to the spa or deck 26" from the end of the spa using 1-1/4" screws. Bracket **F2** must be mounted as close to Pivot Bracket **D** as possible (minimum 6" from Bracket **F1**).

Note: Spa cabinets with little backing or lightweight material where the UNIVERSAL Cover Lifter is to be fastened may need to be reinforced in that area.

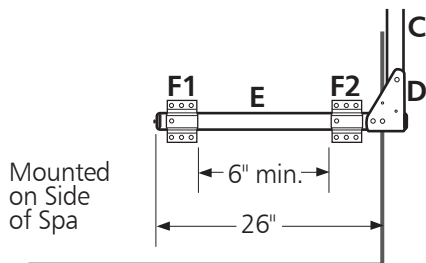

## To assemble and install (continued):

5a. If the cover lifter is to be mounted on the deck, the Mounting Brackets **F1 & F2** must be located so that Main Bar **E** is 1" from the side of the spa cabinet. This distance (1") may vary, depending on the top trim of spa. Customers of deck-mounted UNIVERSAL Cover Lifters can purchase a Mounting Foot for ease of installation.

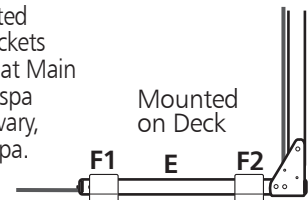

6. Slide Bar **G** into Bar **H**.

7. Make sure that the combined width of Bars **G/H** is long enough so each Adjustment Bar **B** is parallel to the side of the spa when attached. If an adjustment is needed, Bars **G/H** may be cut so that the sides are not flaring in or out. Trim Sleeve **I** to the same length as the combined length of Bars **G/H**. Remove one Adjustment Bar **B** from the sleeve, then attach Bars **G/H** to it. Slide Sleeve **I** over Bars **G/H** and re-insert Adjustment Bar **B**.

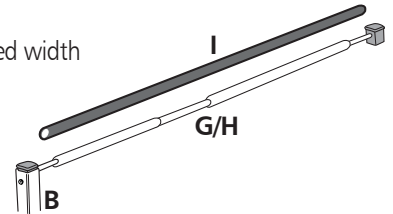

8. Lock Adjustment Bar **B** and Pivot Bar **C** by inserting 1/2" self-drilling screws **J** in the holes provided in Pivot Bar **C**.

9. Insert Wind Pin **K** into hole #2 of Pivot Bracket **D** to lock the UNIVERSAL Spa Cover Lifter in the open position during use to avoid personal injury.

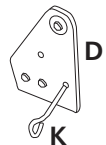

## To move the spa cover off:

1. flip

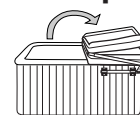

2. rotate

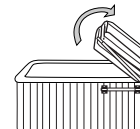

3. THAT'S IT!

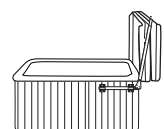

The cover can be easily moved off and of from inside the spa



tel: (604) 856-0275  
 fax: (604) 556-0244  
 www.spacoverremover.ca

# Directions for Assembling, Installing and Using the Universal Spa Cover Lifter w/spring assist

Your **UNIVERSAL** Spa Cover Lifter requires minimal assembly after it is unpackaged.

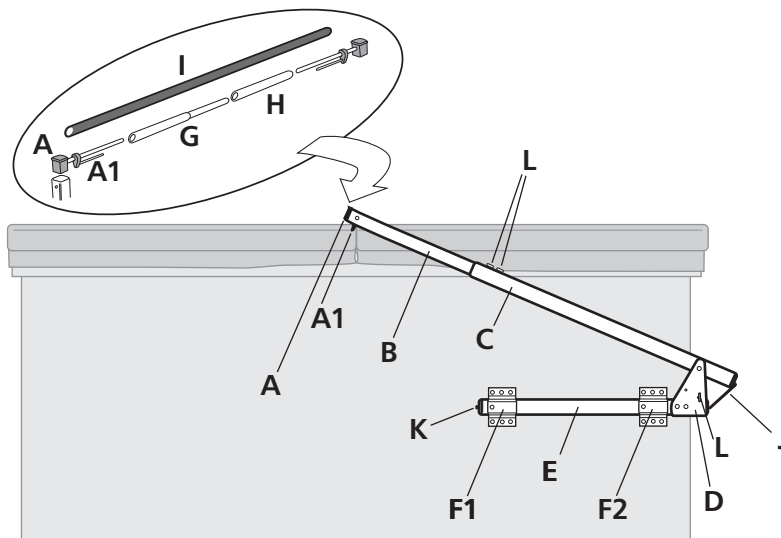

## To assemble and install:

1. Remove the tape and 1/2" #8 self-drilling screw from Adjustment Bar **B**.
2. Insert Connector Bar **A** into Adjustment Bar **B** and fasten with the 1/2" #8 self-drilling screw.

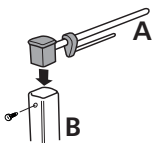

3. Slide Strap Bracket **J** into Pivot Bar **C** and fasten with a 3/4" #8 self-drilling screw.

Note: **Do not loosen Adjustment Screw K.**

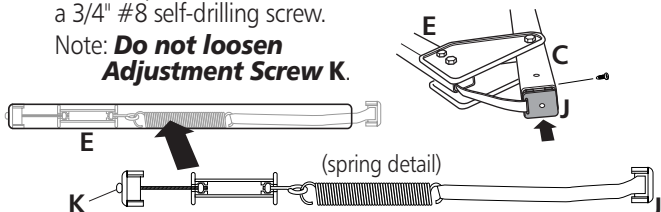

4. Place Connector Bar **A** on the spa cover while sliding Insert Bar **A1** under the spa cover seam.

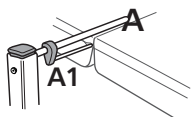

5. While sliding the Adjustment Bar **B** out of the Pivot Bar **C**, locate where you want to mount the UNIVERSAL Spa Cover Lifter on your spa or deck.

Note: *if mounting on deck, brackets **F1** and **F2** must first be turned 90° on Main Bar **E**.*

6. End of Main Bar **E** with Bracket **F1** should be fastened to the spa or deck 26" from the end of the spa using 1-1/4" screws. Bracket **F2** must be mounted as close to Pivot Bracket **D** as possible (minimum 6" from Bracket **F1**).

Note: *Spa cabinets with little backing or lightweight material where the UNIVERSAL Cover Lifter is to be fastened may need to be reinforced in that area.*

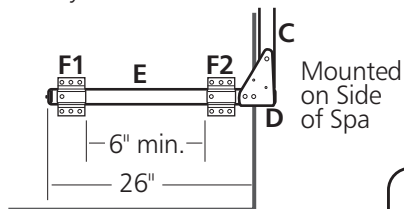

## To assemble and install (continued):

- 6a. If the cover lifter is to be mounted on the deck, the Mounting Brackets **F1** & **F2** must be located so that Main Bar **E** is 1" from the side of the spa cabinet. This distance (1") may vary, depending on the top trim of spa. Customers of deck-mounted UNIVERSAL Cover Lifters can purchase a Mounting Foot for ease of installation.

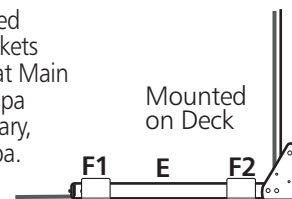

7. Slide Bar **G** into Bar **H**.

8. Make sure that the combined width of Bars **G/H** is long enough so each Adjustment Bar **B** is parallel to the side of the spa when attached. If an adjustment is needed, Bars **G/H** may be cut so that the sides are not flaring in or out. Trim Sleeve **I** to the same length as the combined length of Bars **G/H**. Remove one Adjustment Bar **B** from the sleeve, then attach Bars **G/H** to it. Slide Sleeve **I** over Bars **G/H** and re-insert Adjustment Bar **B**.

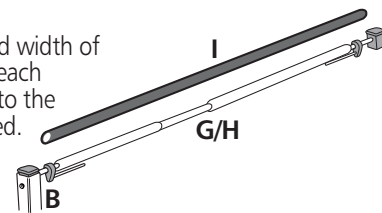

9. Lock Adjustment Bar **B** and Pivot Bar **C** by inserting 1/2" self-drilling Screws **L** in the holes provided in Pivot Bar **C**.

10. Tighten (by turning clockwise) Adjustment Screw **K** until you have the desired tension.

Note: *Adjustment Screw **K** may need to be adjusted periodically to maintain desired tension.*

11. Insert Wind Pin **K** into hole #2 of Pivot Bracket **D** to lock the UNIVERSAL Spa Cover Lifter in the open position during use to avoid personal injury.



## To move the spa cover off:



The cover can be easily moved off and on from inside the spa.



tel: (604) 856-0275  
 fax: (604) 556-0244  
 www.spacoverremover.ca